



exocad

LASAK BioniQ QR Exocad library structure

Scanbody QR, indexed – long
Ref. No. 2815.00



Dummy base shown
in the Exocad library

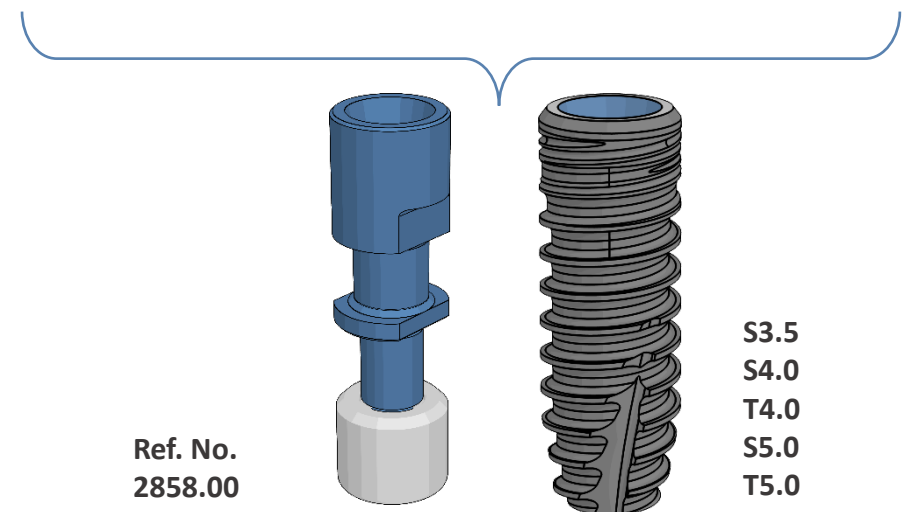
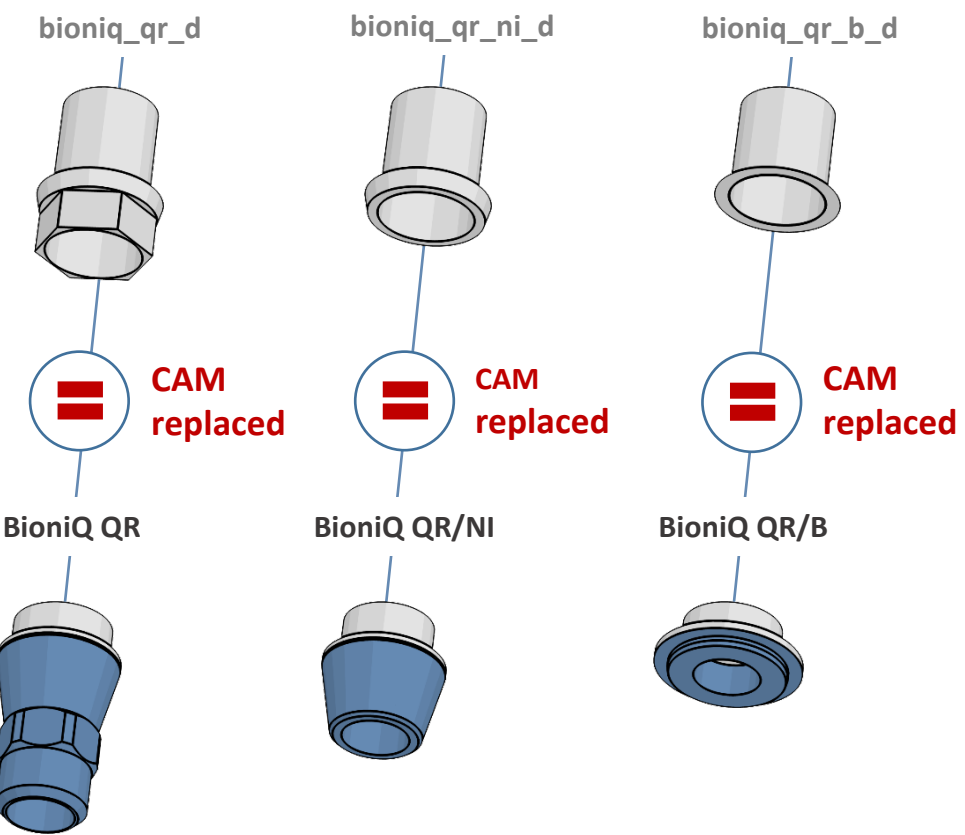



exocad

LASAK BioniQ QN Exocad library structure

Scanbody QN, indexed – long
Ref. No. 2840.00



Dummy base shown
in the Exocad library

bioniq_qn_d

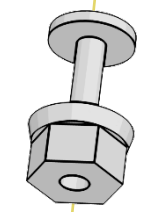

bioniq_qn_ni_d

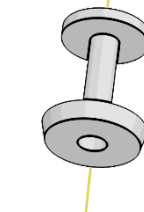

bioniq_qn_b_d

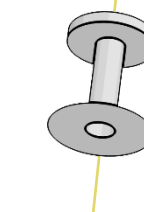

CAM replaced

CAM replaced

CAM replaced

BioniQ QN

BioniQ QN/NI

BioniQ QN/B

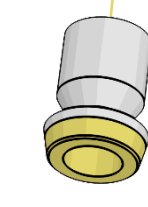
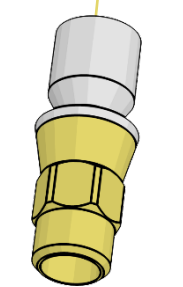

The real base of the
BioniQ component

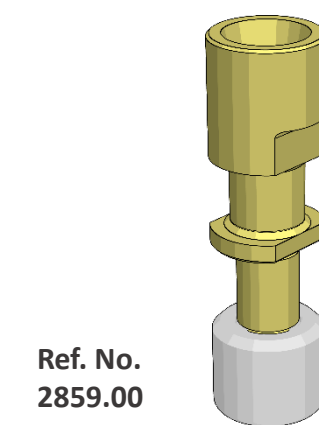

Ref. No.
2859.00

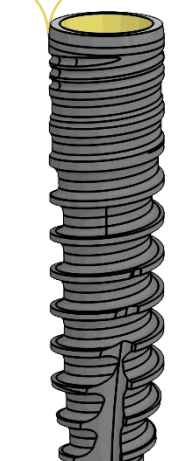

S2.9